



INSTALLATION INSTRUCTIONS

Accessory
SPLASH GUARDS
P/N 08P00-TK8-100B

Application
2016 ODYSSEY

Publications No.
VERSION 1
Issue Date
JULY 2015

PARTS LIST

Left front splash guard

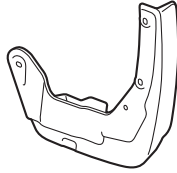

Right front splash guard

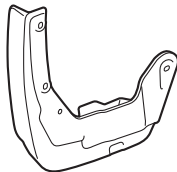

Left rear splash guard

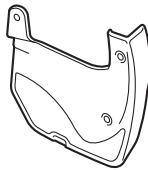

Right rear splash guard

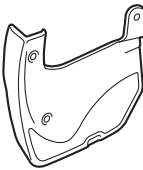

4 Self-tapping screws, 5 x 25 mm



TOOLS AND SUPPLIES REQUIRED

Phillips screwdriver
Stubby Phillips screwdriver
Pushpin
Ratchet
10 mm Socket

Illustration of the Splash Guards Installed on the Vehicle

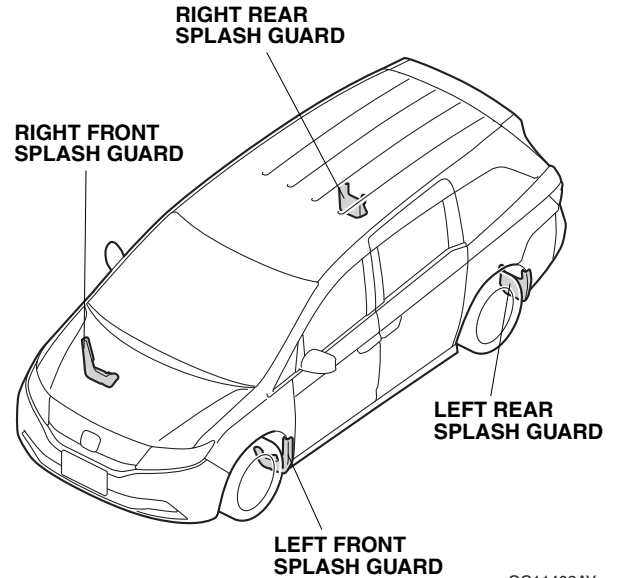

INSTALLATION

Customer Information: The information in this installation instruction is intended for use only by skilled technicians who have the proper tools, equipment, and training to correctly and safely add equipment to your vehicle. These procedures should not be attempted by “do-it-yourselfers.”

NOTE:

- Do not damage the body paint finish.
- Clean and wax the areas to be covered with a high quality paste wax.

Installing the Rear Splash Guards

1. Remove one bolt and three screws from the left rear inner fender and rear bumper.

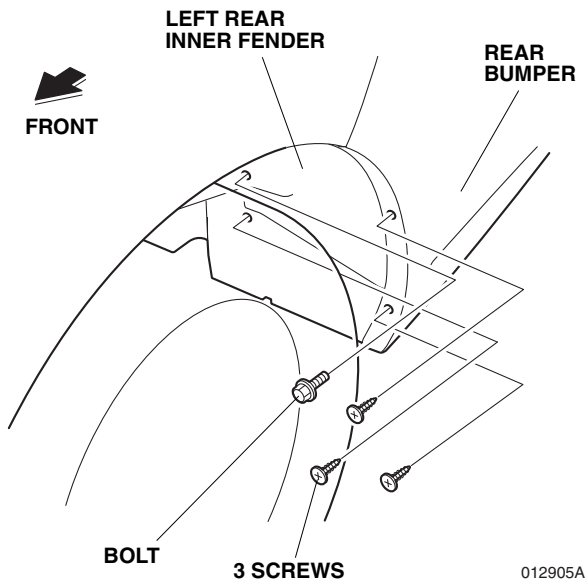

2. Secure the left rear splash guard to the left rear inner fender and rear bumper with one 5 x 25 mm self-tapping screw, one bolt removed step in 1 and two screws removed step in 1. While holding the splash guard firmly against the fenderwell, tighten the self-tapping screw, screws and bolt in the order $1 \rightarrow 2 \rightarrow 3 \rightarrow 4$.

NOTE: Check for a gap between the splash guard and the body. If a gap exists, loosen the screws and repeat the above procedure.

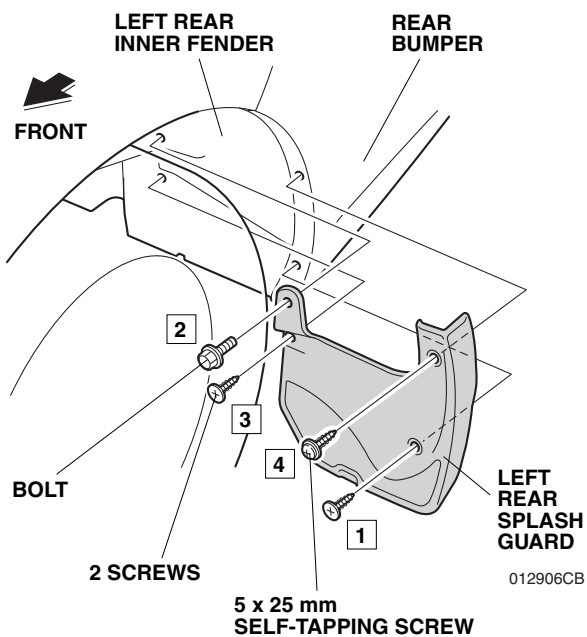

3. Remove one bolt and two screws from the right rear inner fender and rear bumper.

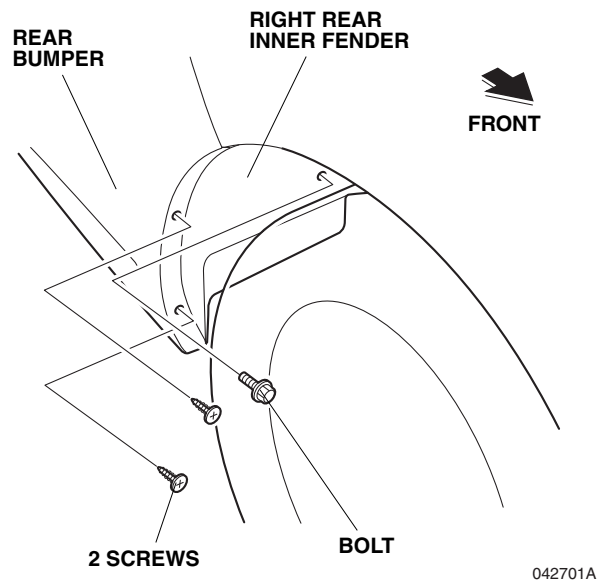

4. Secure the right rear splash guard to the right rear inner fender and rear bumper with one hook, one 5 x 25 mm self-tapping screw, one bolt removed step in 3 and one screw removed step in 3. While holding the splash guard firmly against the fenderwell, tighten the self-tapping screw, screw and bolt in the order $1 \rightarrow 2 \rightarrow 3$.

NOTE: Check for a gap between the splash guard and the body. If a gap exists, loosen the screws and repeat the above procedure.

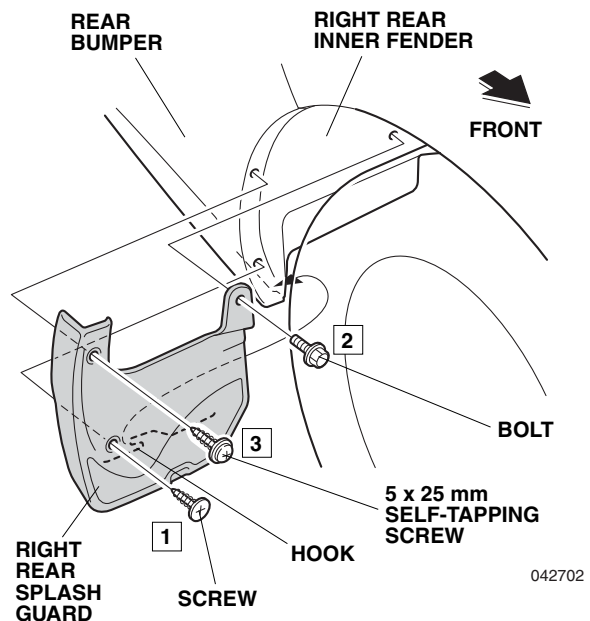

Installing the Front Splash Guards

- Turn the steering wheel fully counterclockwise.

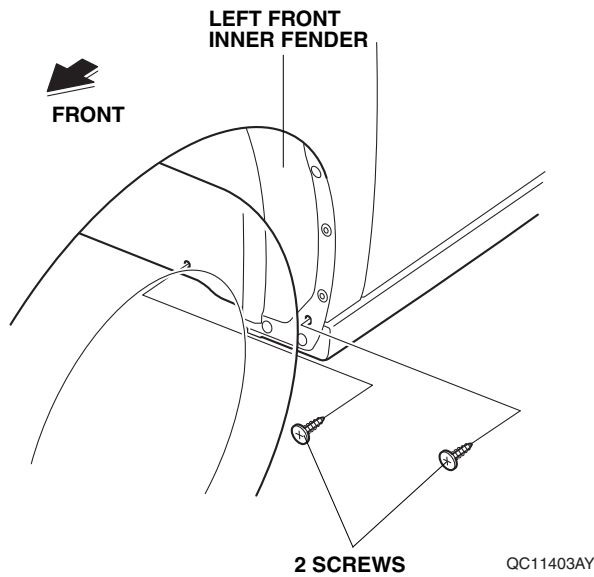

- Remove two screws from the left front inner fender.
- Using a pushpin, pierce the center of two clips on the left front inner fender.

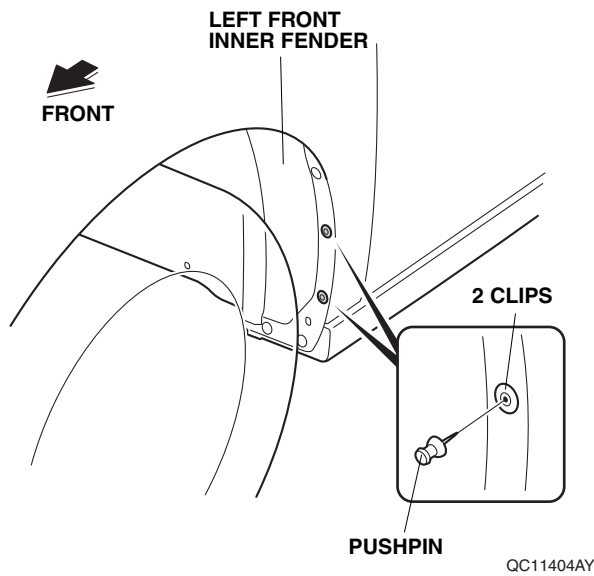

- Secure the left front splash guard to the left front inner fender with one 5 x 25 mm self-tapping screw and three screws removed step in 1 and step in 6. While holding the splash guard firmly against the fenderwell, tighten the self-tapping screw and screws in the order 1 → 2 → 3 → 4.

NOTE: Check for a gap between the splash guard and the body. If a gap exists, loosen the screws and repeat the above procedure.

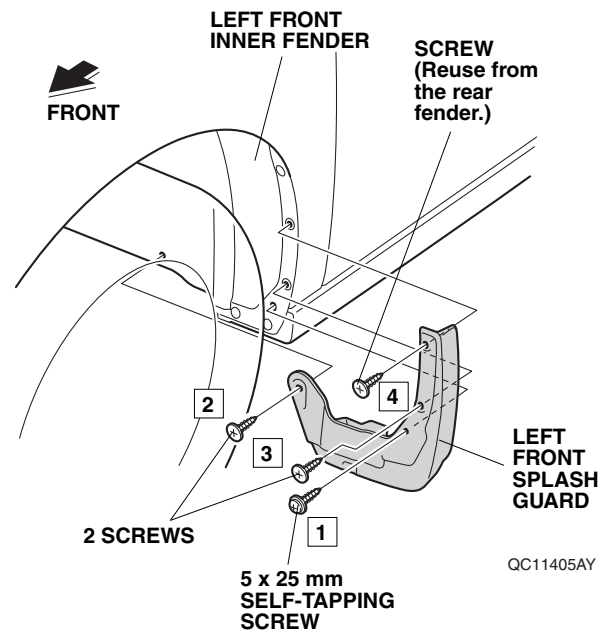

- Turn the steering wheel fully clockwise, and repeat steps 6 through 8 to install the right front splash guard.