



INSTALLATION INSTRUCTIONS

Accessory
CARGO DIVIDER
P/N 08U45-SZA-100A

Application
2009 PILOT

Publications No.
All 39488
Issue Date
MAY 2008

Put this information in the glove box with the vehicle owner's manual.

PARTS LIST

- 4 Cargo dividers

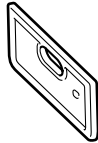

INSTALLATION

Installing the Cargo Divider

1. Open the cargo lid.

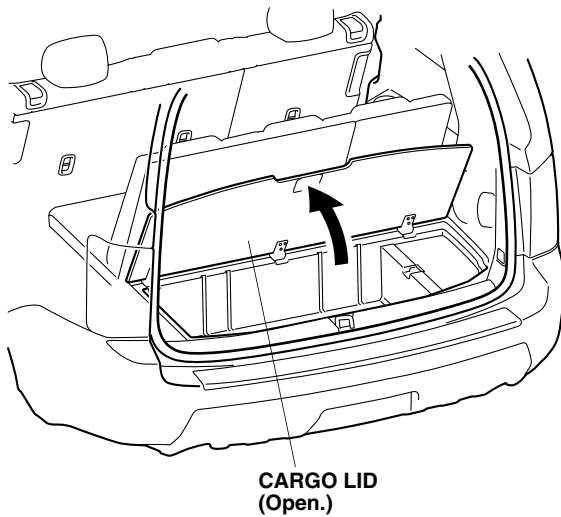

2. Insert four cargo dividers to the recess as shown.

