



INSTALLATION INSTRUCTIONS

Accessory
FULL NOSE MASK
P/N 08P35-TE0-100

Application
2009 ACCORD
2-DOOR

Publications No.
All 40058

Issue Date
JULY 2008

Put this information in the glove box with the vehicle owner's manual.

PARTS LIST

Mask
(hood section)

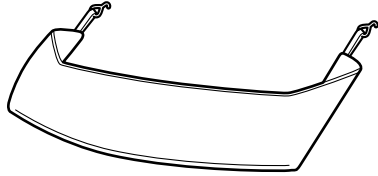

Mask
(bumper section)

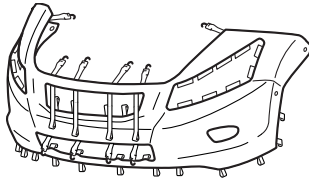

2 Snap-screws A



2 Snap-screws B



2 Washers



2 Fenderwell nuts



Elastic cord

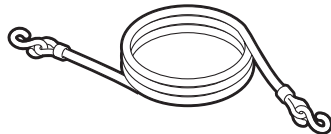

Storage bag

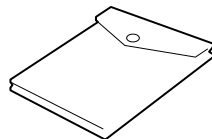

TOOLS AND SUPPLIES REQUIRED

Stubby Phillips screwdriver

Flat-tip screwdriver

INSTALLATION

NOTE:

- Make sure the vehicle and the nose mask are clean and completely dry before installation. If moisture under the mask is allowed to dry, it may cloud the paint. If the mask gets wet, remove it and allow it to air-dry completely.
- Make sure any repainted surfaces are cured.
- Make sure the hood and nose of the vehicle have been waxed with a high-quality paste wax.
- Make sure to install the nose mask securely. If the nose mask starts to flap or comes loose while driving, safely pull off the highway, stop the vehicle, and secure or remove the mask.

Displaying the License Plate

If your state law requires the display of both license plates, cut out the piece of the bumper section that covers the front license plate:

- Face the inside of the mask toward you.
- Carefully cut out the license plate section with scissors at the top seam, and remove the overcast stitching.

Installing the Hood Section

1. Open the hood. Fit the corners of the mask (hood section) around the hood and adjust the mask so that it fits smoothly over the edges. Attach the S-hooks to the hood. Install the S-hooks by inserting your finger into the belt of each S-hook. Pulling the S-hooks by force can break the S-hooks and the mask (hood section).

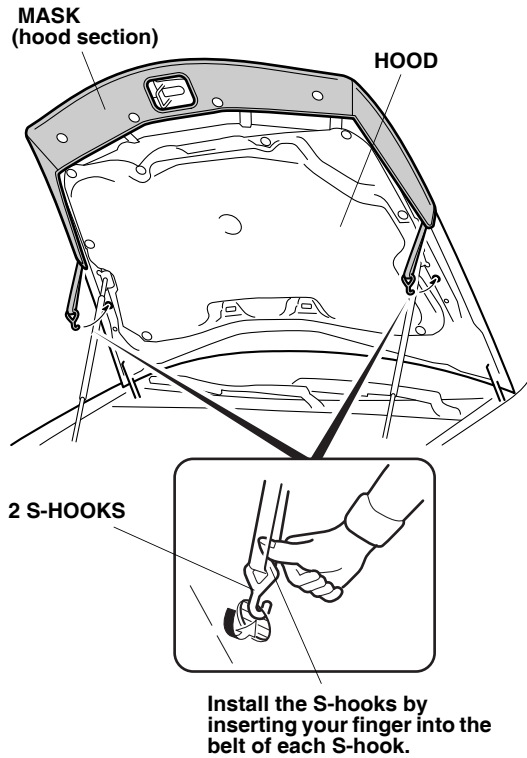

Installing the Bumper Section

2. Turn the steering wheel all the way clockwise.
3. Pry out the second plastic pin, and remove the expansion clip. Remove and retain the clip, then clean the area around the hole.

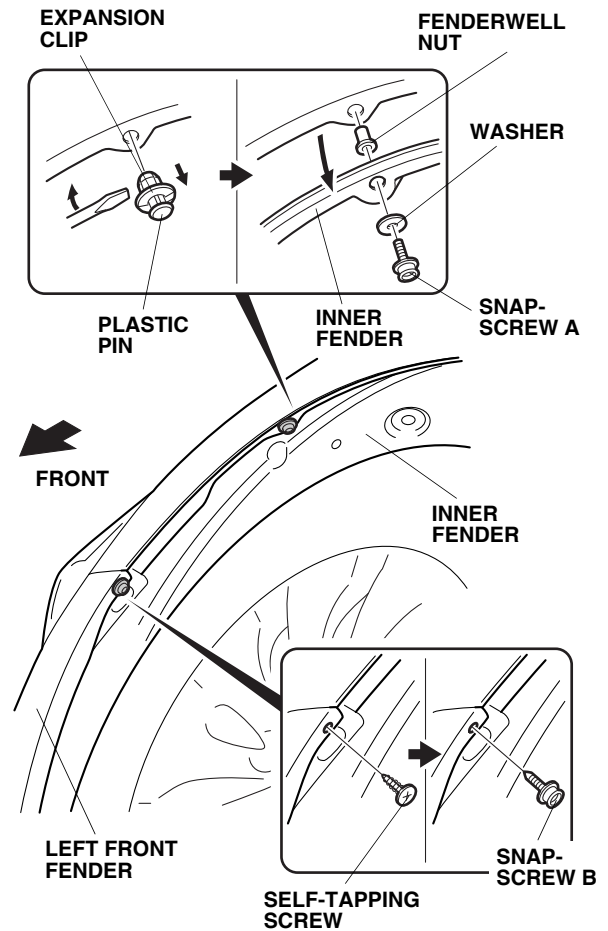

4. Pull the inner fender out, and press one fenderwell nut into the hole on the left front fender.
5. With its washer in place, securely tighten one snap-screw A into the fenderwell nut.
6. Remove the self-tapping screw from the left front fender and install one snap-screw B in its place.
7. Turn the steering wheel all the way counterclockwise, and repeat steps 3 thru 6 on the right side.

- Pull the mask (bumper section) back towards the wheelwell, smooth out any wrinkles, and then snap the mask onto the snap-screw A and B.

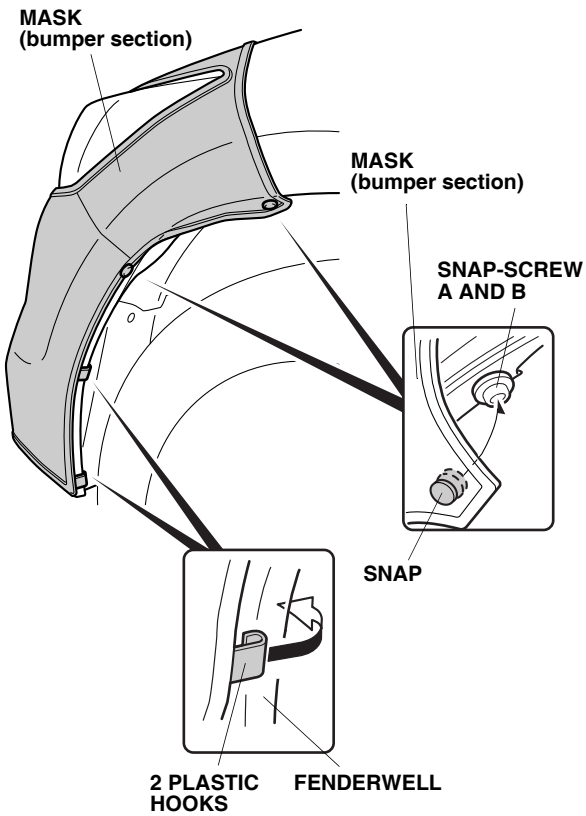

- On each side of the vehicle, attach two plastic hooks to the fenderwell.
- Insert nine tabs between the mask and the left headlight. Repeat on the right side.

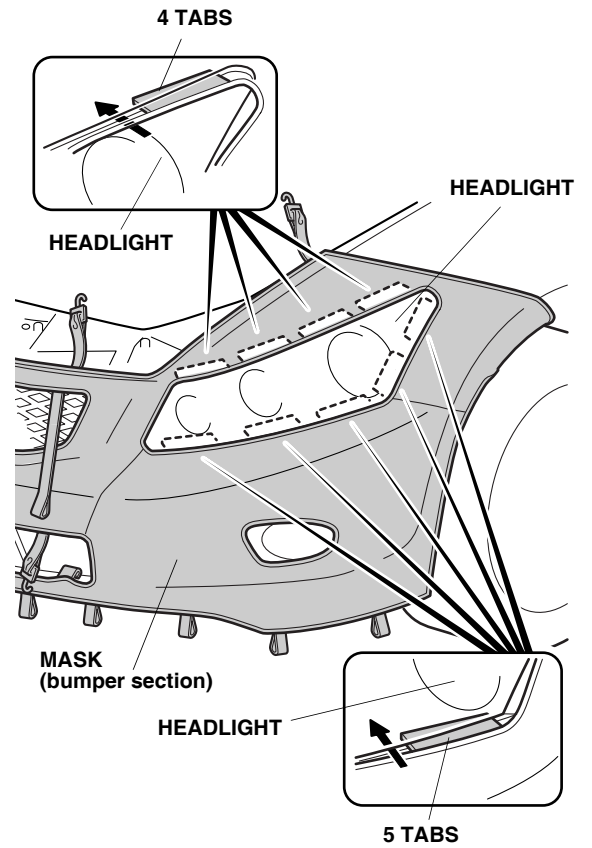

- Attach an S-hook to the left side engine cover.

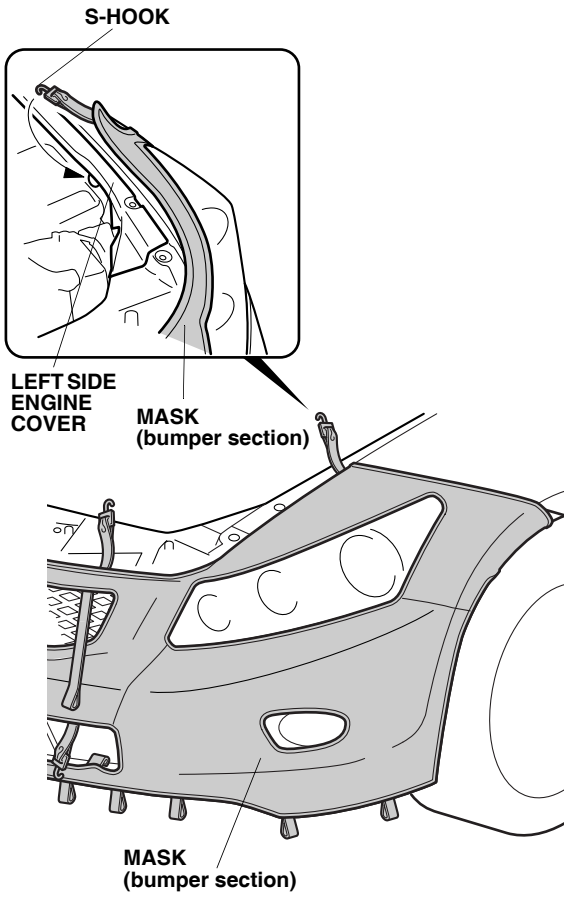

12. Attach two S-hooks to the bottom edge of the radiator cover.

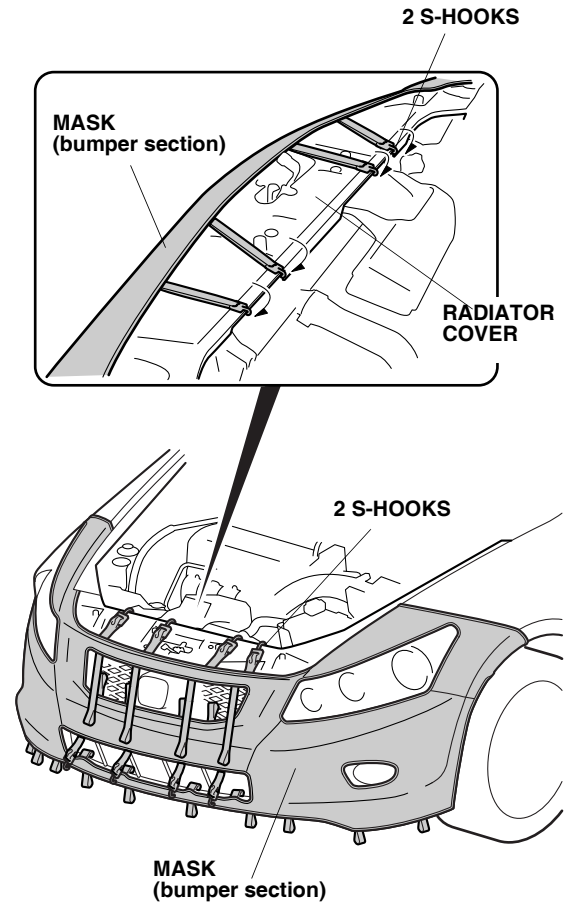

- Route the upper strap of the mask through the inside of the front grille as shown. Then route the upper strap of the mask through the loop on the lower strap of the mask as shown. Repeat on the three other straps.

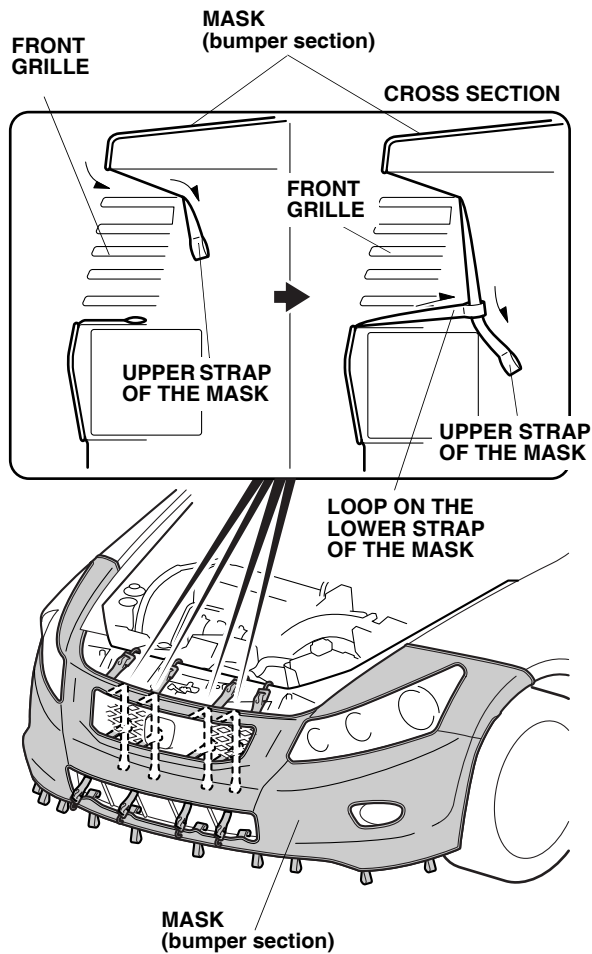

- Continue routing the upper strap of the mask through the inside of the front bumper and attach the S-hook to the loop on the upper strap of the mask as shown. Repeat on the other straps.

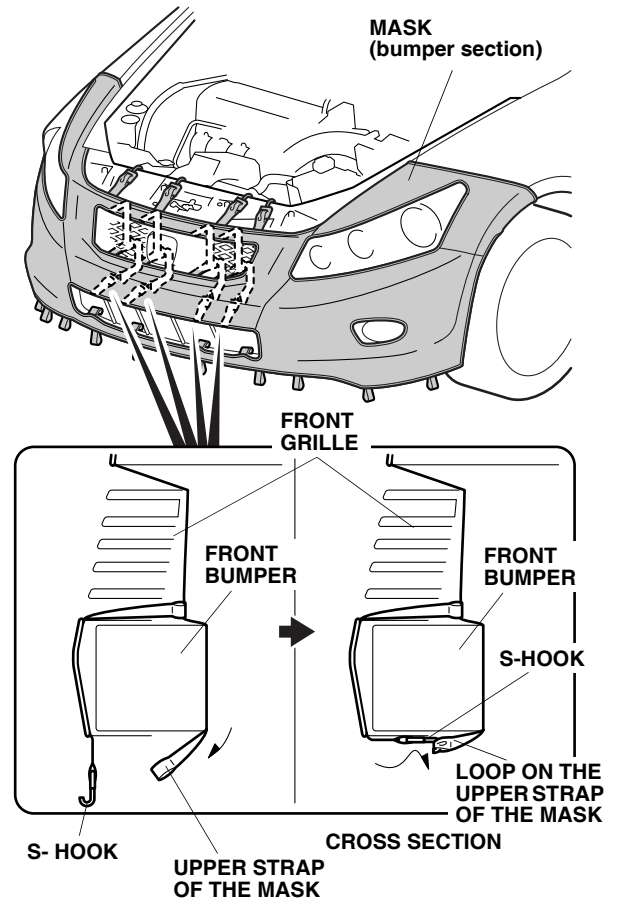

15. Attach the four plastic hooks to the bottom edge of the front bumper.

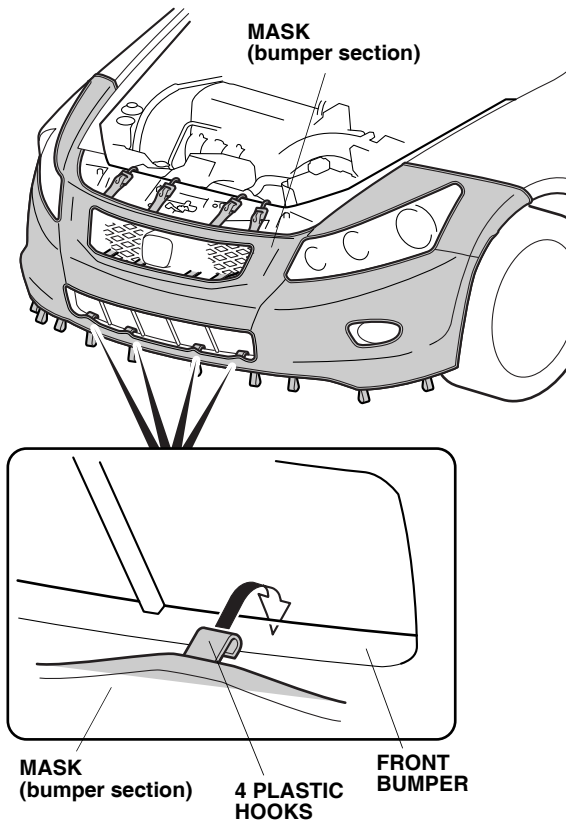

16. Route the elastic cord through the 12 loops on the bottom of the mask. Attach an S-hook to the hole of the inner fender as shown. Attach the other S-hook to the hole of the inner fender to the other side.

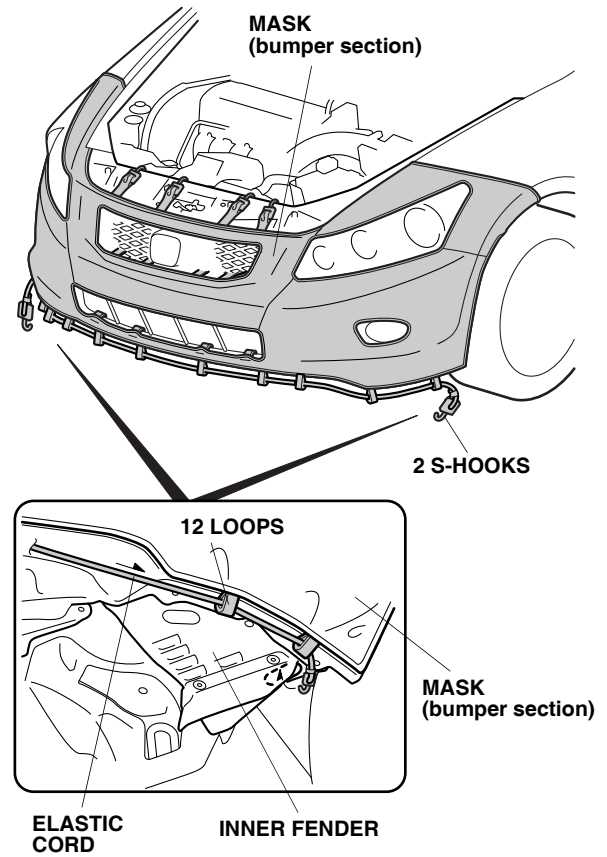

CLEANING THE NOSE MASK

Use a sponge or cloth and a solution of mild liquid dish-washing soap and water to clean the vinyl and the flannel backing. Rinse the mask completely with clean water, and hang it to dry out of direct sunlight. Make sure the mask is completely dry before you reinstall it.