



# INSTALLATION INSTRUCTIONS

Accessory

FULL NOSE MASK  
P/N 08P35-SJC-100

Application

2008 RIDGELINE

Publications No.

All 36606

Issue Date

MAY 2007

Put this information in the glove box with the vehicle owner's manual.

**NOTE:** The nose mask cannot be installed if the vehicle is equipped with fender flares, front lower trim or an air deflector.

## PARTS LIST

Mask  
(bumper section)

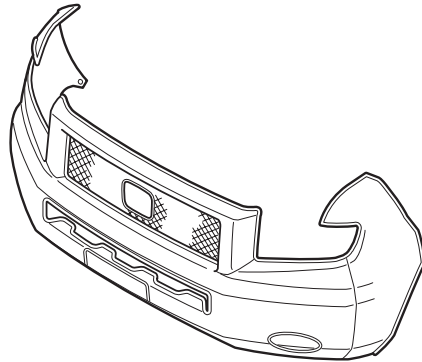

Mask  
(hood section)

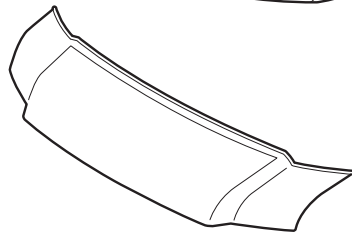

2 Snap-screws



2 Washers



2 Fenderwell nuts



Storage bag

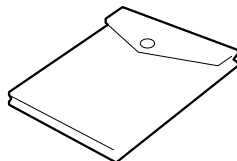

## TOOLS REQUIRED

Stubby #2 Phillips screwdriver

Clip remover

Scissors

## INSTALLATION

### NOTE:

- Make sure the vehicle and the nose mask are clean and completely dry before installation. If moisture under the mask is allowed to dry, it may cloud the paint. If the mask gets wet, remove it and allow it to air-dry completely.
- Make sure any repainted surfaces are cured.
- Make sure the hood and nose of the vehicle have been waxed with a high-quality paste wax.
- Make sure you install the nose mask securely. If the nose mask starts to flap or comes loose while driving, safely pull off the highway, stop the vehicle, and secure or remove the mask.

### Displaying the License Plate

If your state law requires the display of both license plates, cut out the piece of the bumper section that covers the front license plate:

- Face the inside of the mask toward you.
- Carefully cut out the license plate section with scissors at the top seam, and remove the overcast stitching.

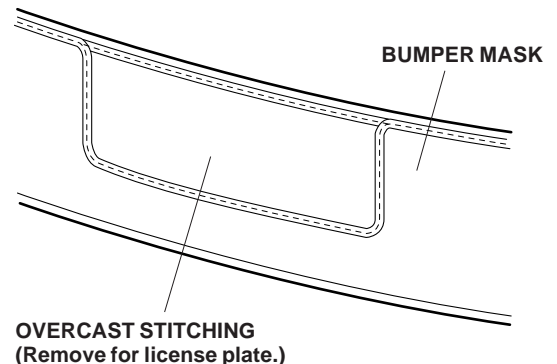

## With Fog Lights

If the vehicle you are working on is equipped with fog lights, cut out the piece of the bumper section that covers the fog lights:

- Face the inside of the mask toward you.
- Carefully cut out the fog lights section with scissors at the top seam, and remove the red overcast stitching.

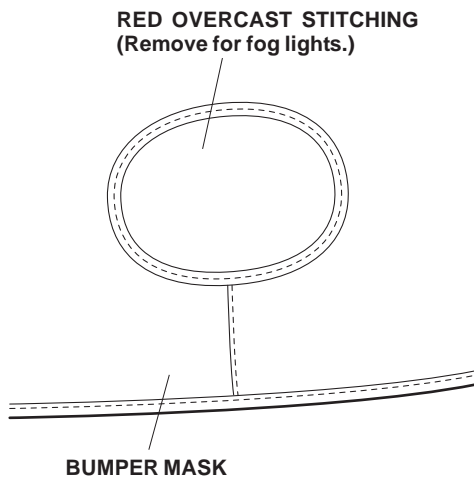

## Installing the Hood Section

1. Open the hood, fit the corners of the hood section around the hood, and adjust the mask so it fits smoothly over the edges. Attach the three hooks to the holes in the hood.

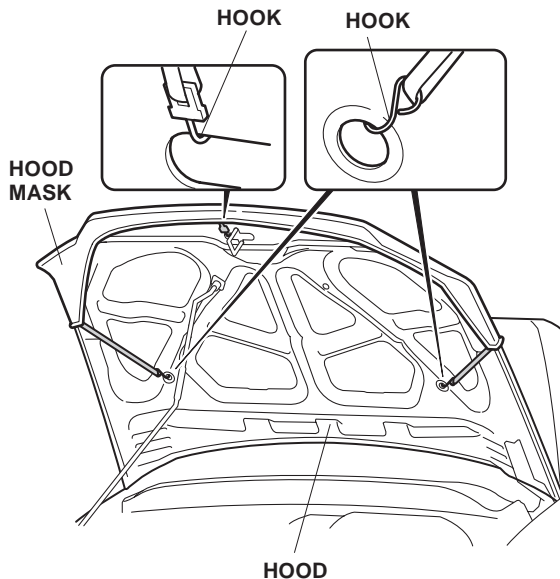

## Installing the Bumper Section

2. Turn the steering wheel all the way clockwise.
3. Pry out the plastic pin, and remove the expansion clip that fastens the inner fender; retain the clip. Clean the area around the hole.

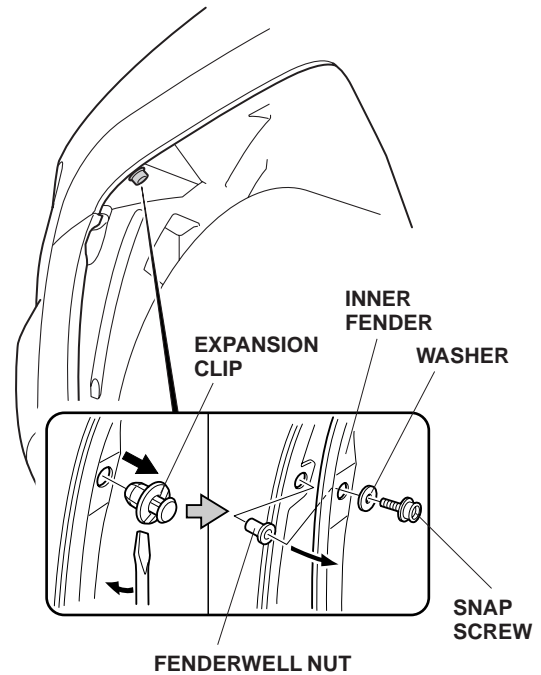

4. Pull the inner fender back, and press one fenderwell nut (supplied) into the hole in the fender flange.
5. With its washer in place, securely tighten one snap-screw into the fenderwell nut.
6. Turn the steering wheel all the way counterclockwise, and repeat steps 3 through 5 on the other side of the vehicle.

- Attach the five hooks to the top inside edge of the bulkhead upper frame and the radiator cover.

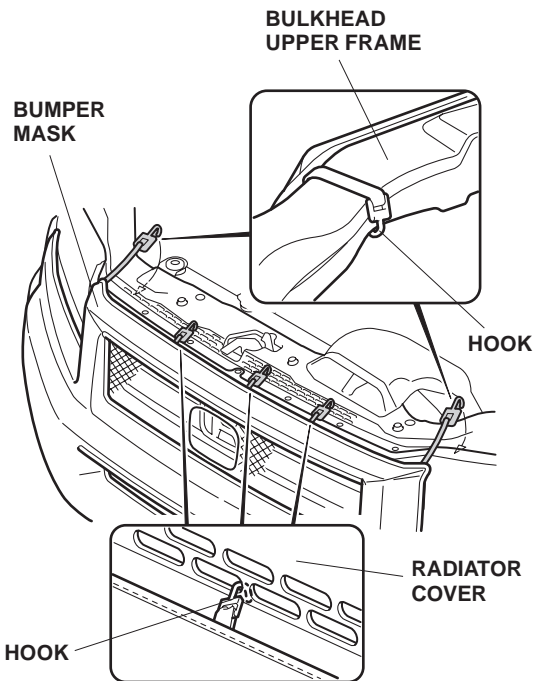

- Pull the mask toward the left fender, and slip the left pocket of the bumper section onto the left front corner of the fender. If necessary, apply downward pressure on the headlight to install the fender pocket.

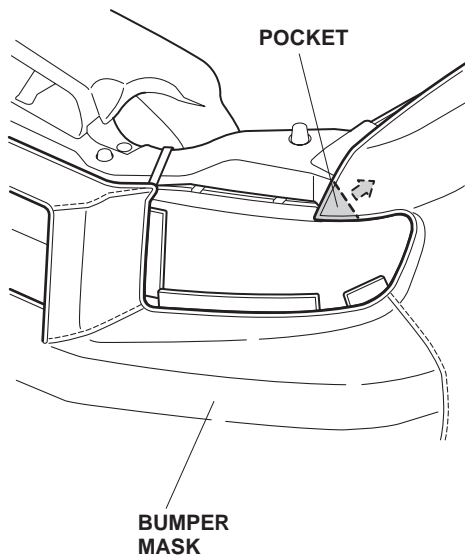

- Attach the plastic clip to the top inside edge of the fender. Fit the mask across the bumper.

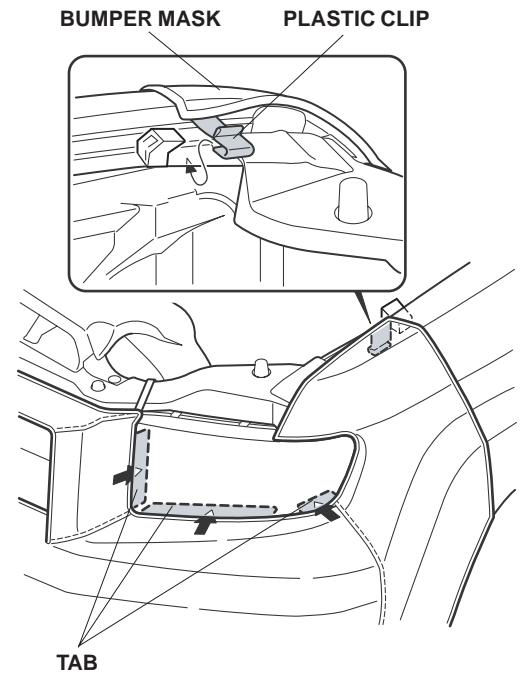

- Insert the three tabs between the headlight and the bumper.
- Repeat steps 8 through 10 to attach the mask on the other side.
- Pull the mask back toward the wheelwell, smooth out any wrinkles, and snap the mask onto the snap-screw. Repeat on the other side.

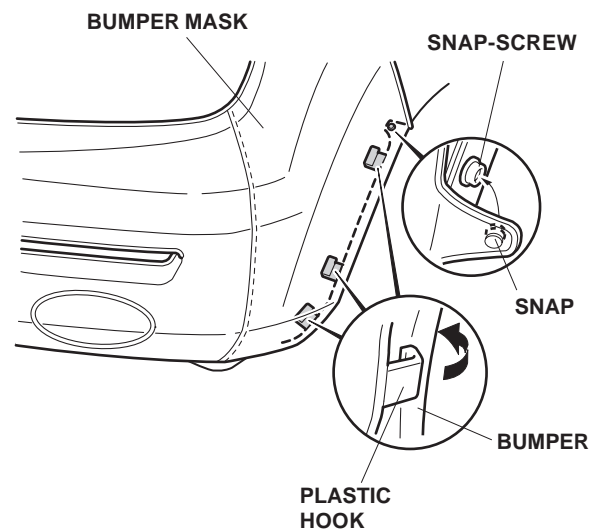

- On both sides of the vehicle, attach the three plastic hooks to the fenderwell.

14. Attach the four plastic clips and the two hooks to the upper bumper grille.

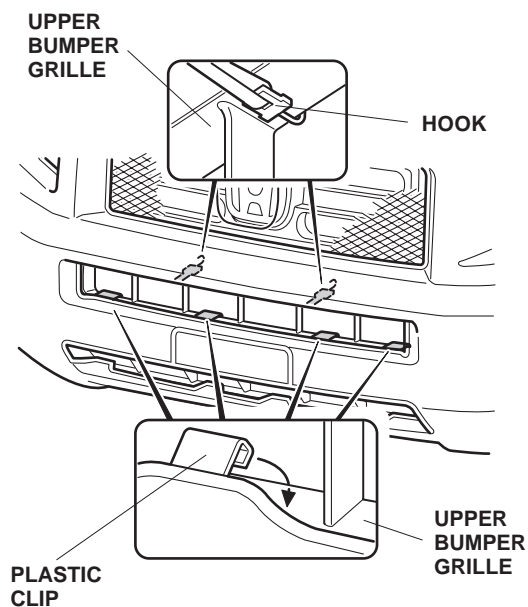

15. Attach the four plastic clips and the two hooks to the lower bumper grille.

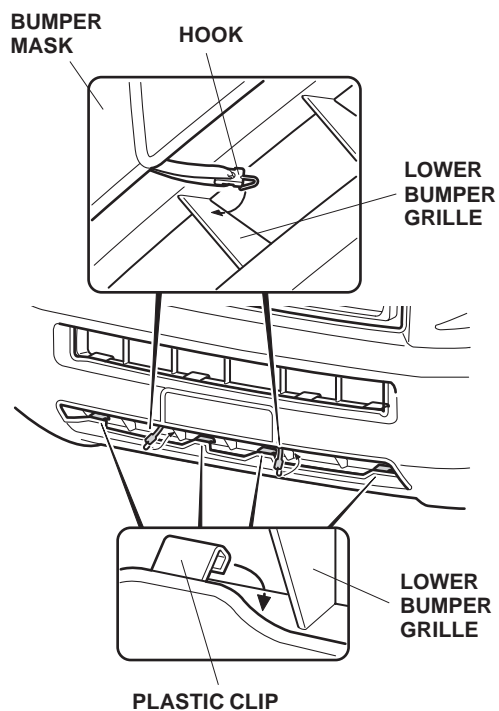

16. Attach the six hooks to the bottom inside edge of the front bumper.

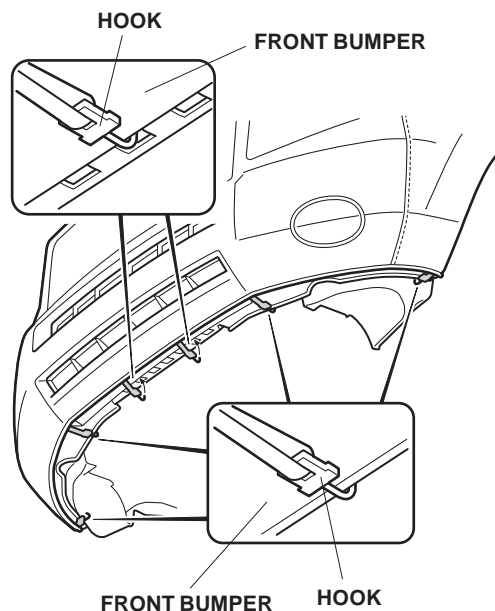

17. Put the plastic pins and expansion clips (removed in step 3) into the storage bag, and place it in the trunk.

### CLEANING THE NOSE MASK

Use a sponge or cloth and a solution of mild liquid dishwashing soap and water to clean the vinyl and the flannel backing. Rinse the mask completely with clean water, and hang it to dry, out of direct sunlight. Make sure the mask is completely dry before you reinstall it.