



INSTALLATION INSTRUCTIONS

Accessory FULL NOSE MASK P/N 08P35-SWA-100	Application 2008 CR-V	Publications No. All 40366
		Issue Date AUG 2008

PARTS LIST

Mask
(hood section)

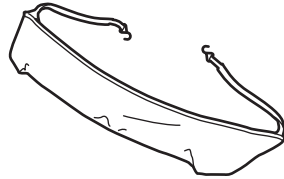

Mask
(bumper section)

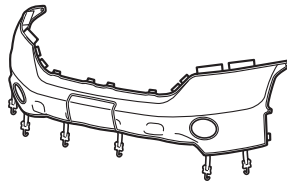

2 Snap-screws A

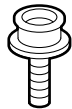

2 Snap-screws B



4 Washers



2 Fenderwell nuts



Storage bag

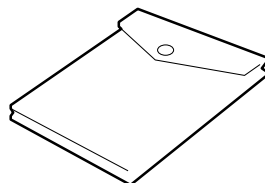

TOOLS AND SUPPLIES REQUIRED

Stubby Phillips screwdriver

Flat-tip screwdriver

Scissors

INSTALLATION

NOTE:

- Make sure the vehicle and the nose mask are clean and completely dry before installation. If moisture under the mask is allowed to dry, it may cloud the paint. If the mask gets wet, remove it and allow it to air-dry completely.
- Make sure any repainted surfaces are cured.
- Make sure the hood and nose of the vehicle have been waxed with a high-quality paste wax.
- Make sure to install the nose mask securely. If the nose mask starts to flap or comes loose while driving, safely pull off the highway, stop the vehicle, and secure or remove the mask.

Displaying the License Plate

If your state law requires the display of both license plates, cut out the piece of the bumper section that covers the front license plate:

- Face the inside of the mask toward you.
- Carefully cut out the license plate section with scissors at the top seam, and remove the overcast stitching.

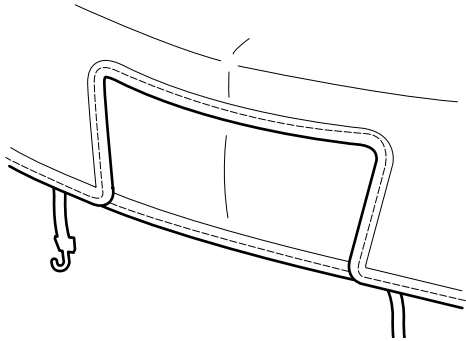

Installing the Hood Section

1. Open the hood. Fit the corners of the mask (hood section) around the hood. Adjust the mask (hood section) so that it fits smoothly over the edges. Attach the S-hooks to the hood. Install the S-hooks by inserting your finger into the belt of each S-hook. Pulling the S-hooks with force can break the S-hooks and mask hood section.

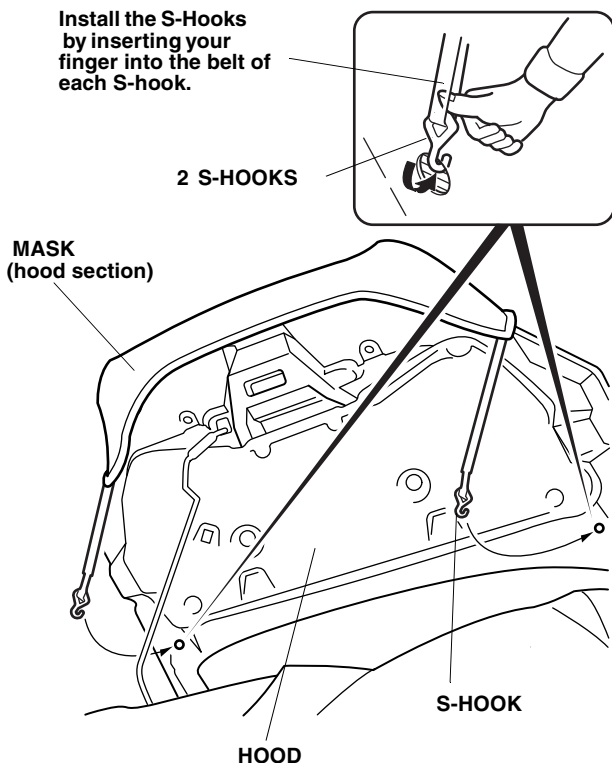

Installing the Bumper Section

2. Turn the steering wheel all the way clockwise.
3. Pry out the plastic pin, and remove the expansion clip that fastens the inner fender. Remove and retain the clip, then clean the area around the hole.
4. Pull the inner fender out, and press a fenderwell nut into the hole in the left front fender.
5. With its washer in place, securely tighten snapscrew A into the fenderwell nut.
6. Remove the self-tapping screw from the left front fender. Secure snap-screw B with a washer in its place.
7. Turn the steering wheel all the way counterclockwise, and repeat steps 3 thru 6 on the right side.

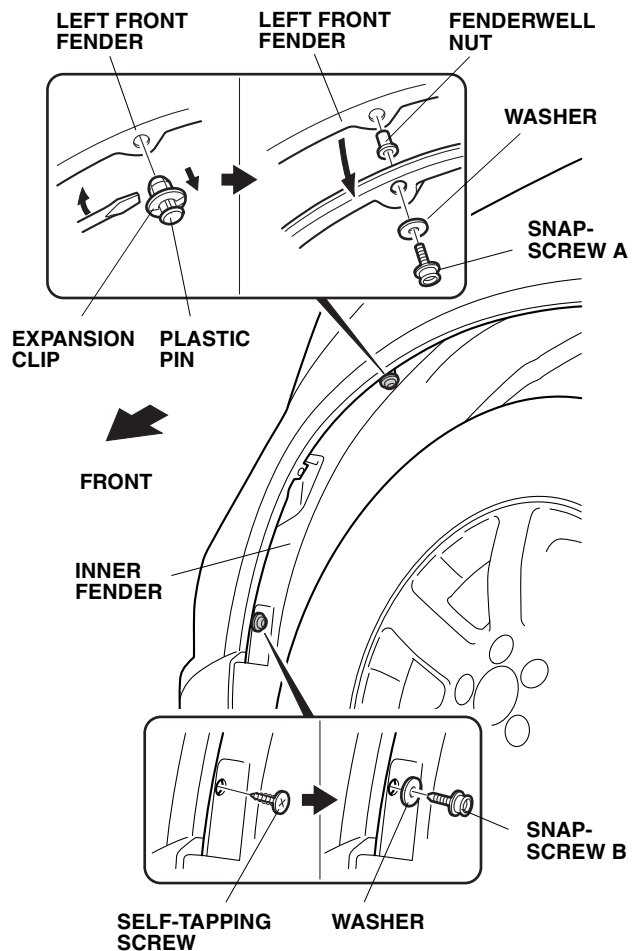

8. Pull the mask (bumper section) back toward the wheelwell, smooth out any wrinkles, and then snap the mask (bumper section) onto snap-screws A and B. Attach the plastic hook to the fenderwell as shown.
9. Repeat step 8 on the right side.

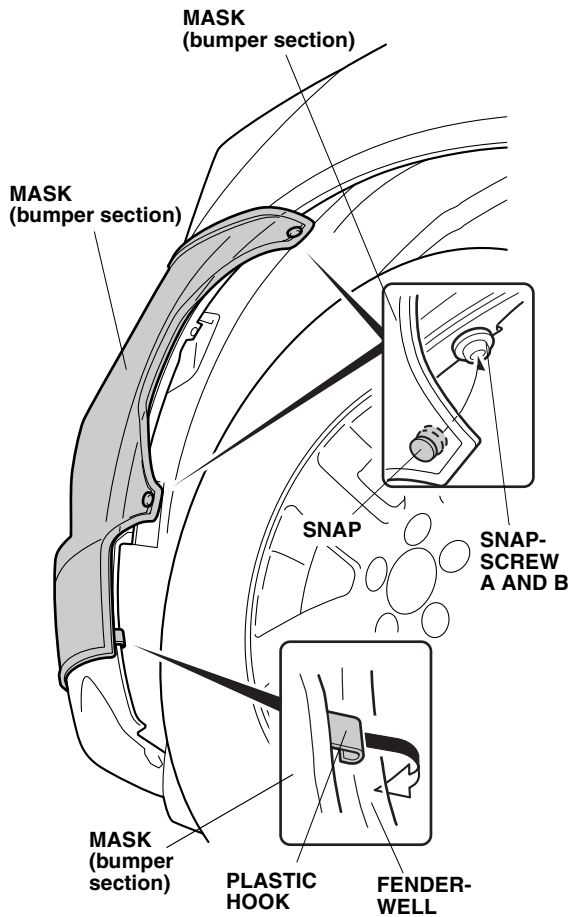

10. Insert the four tabs between the headlight and grille. Repeat on the right side.

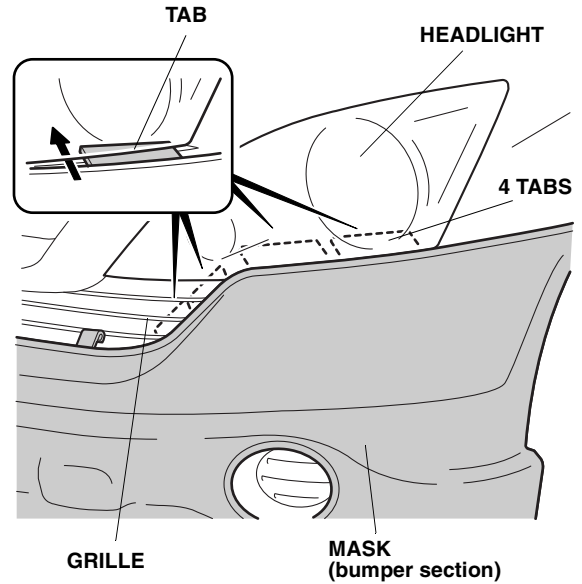

11. Attach the four plastic hooks to the top inside edge of the front bumper.

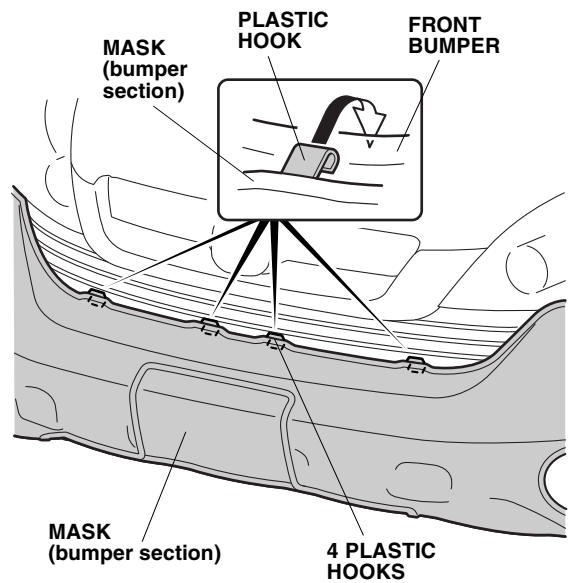

12. Attach the two plastic hooks and two S-hooks to the bottom inside edge of the front bumper.

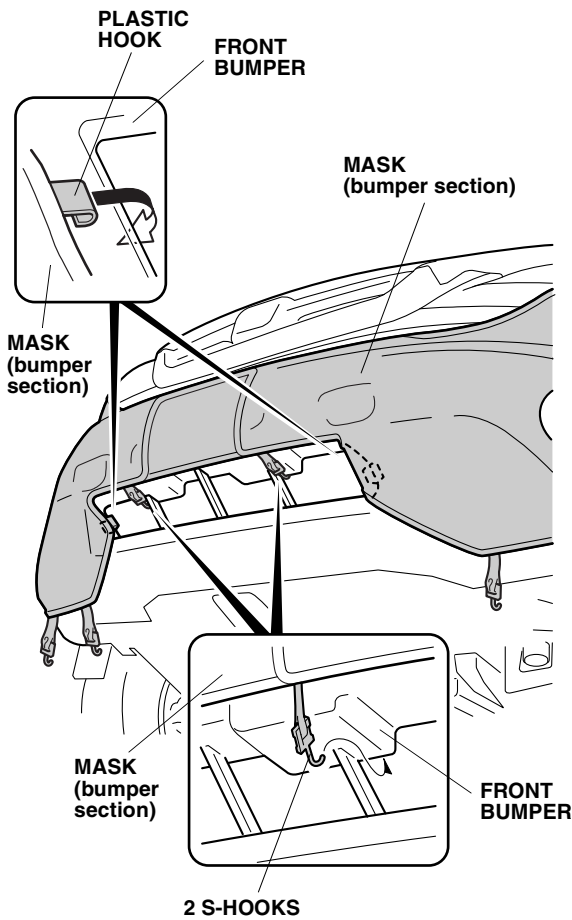

13. Attach four S-hooks to the bottom inside edge of the front bumper and inner fender as shown.

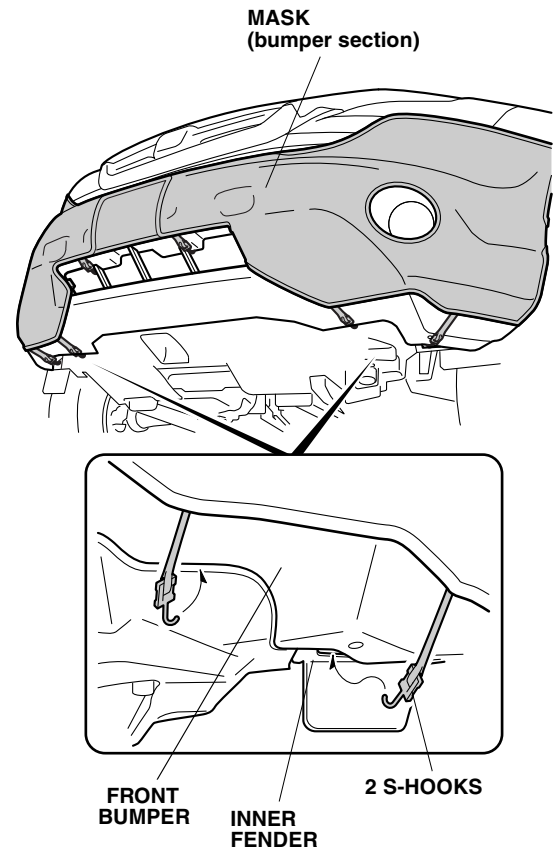

CLEANING THE NOSE MASK

Use a sponge or cloth and a solution of mild liquid dish-washing soap and water to clean the vinyl and the flannel backing. Rinse the mask completely with clean water, and hang it to dry out of direct sunlight. Make sure the mask is completely dry before you reinstall it.